



# **User's Manual**

## **XC2907-A Portable Reader**

## Thank you for using Invengo's RFID products!

---

We are very glad that you chose this XC2907-A portable reader. We hope that the equipment can facilitate your work. The picture is for reference only and the physical product shall be subject to.



# Foreword

This manual applies to the following model:

XC2907-A portable reader.

This manual provides information on the use, maintenance and other features of the product for the product users and maintenance personnel.

 or  trademark belongs to Invengo.

All instructions and descriptions of product features and functions in this manual, as well as other information, are up-to-date and valid information. All information is accurate when printed. INVENGO reserves the right to correct or change the information and instructions in this manual without prior notice or any liability.

Because of your special needs, some features of the product will vary depending on the configuration.

## Safety Instructions



### Warning sign

If operate improperly, it may result in damage to your equipment(s).



### Attention

If ignored, it may result in unsuccessful operation

If ignored, it may cause undesirable effect

# Content

<b>1. Product overview</b> .....	<b>1</b>
1.1 Product profile .....	1
1.2 Main usage and application scope .....	1
1.3 Working environment and conditions .....	1
1.4 Safety and protective measures .....	2
<b>2. Performance parameters</b> .....	<b>2</b>
2.1 Main functions .....	2
2.2 Technical parameters .....	2
<b>3. Dimensions and weight</b> .....	<b>5</b>
3.1 Dimensions .....	5
3.2 Weight .....	6
<b>4. Structural characteristics and operating principle</b> .....	<b>6</b>
4.1 Appearance description .....	6
4.2 Installation and removal of battery .....	7
4.3 Shutdown / Standby / Restart .....	7
<b>5. Common functions and settings</b> .....	<b>8</b>
5.1 Data synchronization between installing USB drive and PC .....	8
5.2 Backlight regulation .....	9
5.3 Volume and sound .....	9
5.4 Instructions for All-Netcom Network (data) .....	10
5.5 Wi-Fi instructions .....	10

<b>5.6 Instructions for Bluetooth .....</b>	<b>11</b>
<b>5.7 Instructions for GPS .....</b>	<b>12</b>
<b>5.8 Instructions for barcode module .....</b>	<b>12</b>
5.8.1 Technical specification and support format for barcode engine .....	12
5.8.2 Barcode reading of demo software .....	13
<b>5.9 Instructions for camera .....</b>	<b>13</b>
<b>6. Introduction for RFID module .....</b>	<b>14</b>
<b>6.1 Description of RFID module .....</b>	<b>14</b>
6.1.1 Module instruction .....	14
6.1.2 Technical parameters of RFID module .....	14
<b>6.2 Instructions for API interface program .....</b>	<b>15</b>
<b>6.3 Instructions for demo software .....</b>	<b>15</b>
6.3.1 Demo software application environment .....	15
6.3.2 Software installation and start-up .....	15
6.3.3 Software running .....	16
<b>6.4 Main operating instructions for demo software .....</b>	<b>17</b>
6.4.1 Scan Setting .....	17
6.4.2 Power setting .....	18
6.4.3 Tag filter configuration .....	19
6.4.4 Search the tag .....	20
6.4.5 Session configuration .....	20
6.4.6 Q value configuration .....	21
<b>7. Tag operation .....</b>	<b>21</b>
<b>7.1 Writing EPC .....</b>	<b>22</b>
<b>7.2 Read user field data .....</b>	<b>23</b>
<b>7.3 Write user field data .....</b>	<b>23</b>
<b>7.4 Writing BANK .....</b>	<b>24</b>
<b>7.5 Wiping BANK .....</b>	<b>24</b>

7.6 Configuration password .....	25
7.7 Configure lock status .....	26
7.9 EAS logo configuration .....	27
7.10EAS Monitoring configuration .....	28
7.11EPC filter .....	28
<b>8. Precautions .....</b>	<b>29</b>
8.1 Description of use of power saving .....	29
8.2 Exception declaration .....	29
8.3 The correct mode to replace the battery .....	30
<b>9. Daily maintenance and troubleshooting .....</b>	<b>30</b>
9.1 Routine maintenance .....	30
9.2 Analysis and troubleshooting of common problems .....	31
9.3 RF communication optimization .....	32
9.3.1 Signal interference problem .....	33
9.3.2 Information attenuation / reflection .....	33
<b>10. Transport and storage .....</b>	<b>35</b>
10.1 Transport requirements .....	35
10.2 Storage requirements .....	35
<b>11. Packing and unpacking inspection .....</b>	<b>36</b>
11.1 Packing descriptions .....	36
11.2 Unpacking .....	36
<b>12. After-sales service method .....</b>	<b>37</b>
12.1 After-sales service .....	37
12.2 Other items .....	37

# 1. Product overview

## 1.1 Product profile

Welcome to use XC2907-A portable reader. This portable reader is a new portable reader developed by our company in combination with the needs of IOT application scenarios. This product is an intelligent and multi-functional UHF-RFID tag reader with fast processing speed, good portability and high functional integration.



Figure 1-1 XC2907-A portable reader

## 1.2 Main usage and application scope

With abundant functions, XC2907-A portable reader can be widely applied in multiple fields, such as: clothing retail, warehouse management, asset management, textile washing, etc.

## 1.3 Working environment and conditions

XC2907-A portable reader has the following specific requirements for the working environment:

Working temperature:  $-20^{\circ}\text{C} \sim 50^{\circ}\text{C}$

Storage temperature:  $-20^{\circ}\text{C} \sim 70^{\circ}\text{C}$

Working humidity: 5%-95% (non-condensing,  $+25^{\circ}\text{C}$ )

Storage humidity: 5%-95% (non-condensing, +25°C)

## 1.4 Safety and protective measures

When this reader works (radiated microwave), don't aim at people and animals for a long time!



Before using, please refer to the contents in the precautions.



Any radio transmission equipment, including this equipment, may interfere with the work of medical equipment without proper protection. If there is a problem,



consult the manufacturer of the medical equipment concerned. The work of the equipment may interfere with other electronic equipment.

## 2. Performance parameters

### 2.1 Main functions

- Support EPC Global UHF Class 1 Gen 2/ISO18000-6C and ISO1800-6B protocols;
- Support the wireless transmission of data information via 4G network (data), Wi-Fi, Bluetooth, etc.;
- Support GPS positioning;
- Support the identification and reading of mainstream 1D and 2D barcodes
- Support the camera
- Users can easily master the usage with a simple operating interface
- Support touch screen and Chinese character/data input
- Provide Java SDK and standard environment for secondary development

### 2.2 Technical parameters

The performance parameters are shown as Table 2:

Table 2 Performance parameters



## 2. Performance parameters

Processor	8-core 64-bit processor	
Memory	System memory: RAM: 4GB+ROM: 64GB (Standard configuration)	
Operating system	Android 10.0	
Power supply	<p>Main battery: Polymer lithium ion 3.7V 4900mAh/9000mAh</p> <p>Adapter: AC input: 100V~240V/50Hz~60Hz</p> <p>DC output: DC5V/2A</p> <p>Battery life: More than 14 hours for normal use, more than 200 hours for standby mode</p> <p>Working state: Real-time monitoring of battery voltage, residual power and charging status</p>	
Development environment	<p>Operating environment: Android 10.0</p> <p>SDK: INVENGO software development kit</p> <p>Development language: Java</p> <p>Development tool: Eclipse/Android Studio</p>	
Application software	<p>RFID Demo barcode demo software</p> <p>Barcode demo software</p>	
UHF-RFID module	<p>Support protocol: EPC Global UHF Class 1 Gen 2/ ISO18000-6C/ISO1800-6B</p> <p>Working frequency: 920-925MHz</p> <p>Output power: 0dBm ~ 30dBm (stepping 1dB)</p> <p>Debug mode: PR-ASK</p> <p>Read-write distance: 0~10.0m for reading tags, 0~5m for writing tags (specific tag and environment)</p> <p>Maximum tag capacity:</p> <ul style="list-style-type: none"> <li>● EPC area supports 62 bytes at most</li> <li>● TID area supports 16 bytes at most</li> <li>● User data field supports 8K bytes at most</li> </ul>	
WWAN (China) All-Netcom	4G	TDD: B38/B39/B40/B41 FDD: B1/B3/B5/B7
	3G	WCDMA: B1/B2/B5/B8
	2G	GSM/GPRS/Edge (850/900/1800/1900MHz)

<p>Wi-Fi Function</p>	<p>Support protocol: IEEE802.11a/b/g/n</p> <p>Communication rate: 2.4GHz and 5GHz dual-band</p> <p>Transmission distance:</p> <ul style="list-style-type: none"> <li>● Indoor 20m (No obstacles)</li> <li>● Outdoor 50m (No obstacles)</li> </ul>
<p>Bluetooth function</p>	<p>Bluetooth V4.2</p> <ul style="list-style-type: none"> <li>• If the distance is less than 10m (no obstacles), play music without noise with Bluetooth headset; If the distance is less than 8m, talk with Bluetooth headset without noise;</li> <li>• If the distance is less than 4m (no obstacles), the files can be normally transmitted and received through the Bluetooth function.</li> </ul>
<p>GPS positioning</p>	<p>GPS/Beidou (optional)</p> <p>Error ±5m</p>
<p>Barcode engine</p>	<p>Support code system:</p> <ul style="list-style-type: none"> <li>• 1D code system: Code39, Code93, Code128, Codebar, EAN-13, EAN-8, UPC-A, UPC-E, ITF14, UCC/EAN-128, ITF25, Matrix25, EAN-128, ISBN, etc.</li> <li>• 2D code system: PDF417, MicroPDF417, Composite, RSS, TLC-39, Datamatrix, QRcode, MicroQRcode, Aztec, MaxiCode, PostalCodes, USPostNet, USPlanet, UKPostal, AustralianPostal, JapanPostal, DutchPostal, etc.</li> </ul>
<p>Camera module</p>	<p>Front 500W camera and rear 1300W camera, with flashlight and automatic focusing functions</p>
<p>User interface</p>	<p>LCD screen:</p> <ul style="list-style-type: none"> <li>• Bright white backlight can adjust brightness of backlight manually</li> <li>• 720×1440 resolution, 5.5-inch IPS HD screen</li> </ul> <p>Touch screen: Capacitive touch screen</p> <p>Speaker and indicator:</p> <ul style="list-style-type: none"> <li>● Built-in monaural speaker</li> <li>● Charge indicator (red light)</li> <li>● Network indicator</li> </ul>

Internal expansion	Support MicroSD/TF card extension and 256GB at most
External port	Type-C interface Power input port
Applicable environment	Working temperature: -20°C~50°C Storage temperature: -20°C~70°C Humidity: 5%-95% (non-condensing, +25°C) Vibration resistance: GB/T 2423.10-2008; Acceleration 4.9m/s <sup>2</sup> ; Frequency range 5Hz-100Hz Driving amplitude (peak mm) 25/f(f=5Hz~10Hz), 250/f <sup>2</sup> (f=10Hz~100Hz)
Accessories	<ul style="list-style-type: none"> <li>• Power adapter (DC 5V/2A)</li> <li>• USB cable</li> </ul>

## 3. Dimensions and weight

### 3.1 Dimensions

XC2907-A portable reader is delicate and beautiful. The external dimensions are shown in Figure 3-1:

Length × width × height = 170mm×103mm×150mm

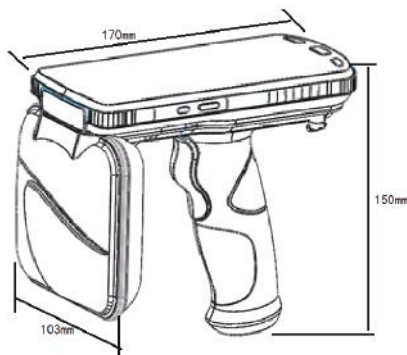

**Figure 3-1 Schematic diagram of external dimensions of XC2907-A portable reader**

## 3.2 Weight

XC2907-A portable reader has a delicate appearance and light weight. The machine weight is about: 650g (related to the quantity of optional modules).

# 4. Structural characteristics and operating principle

This chapter mainly details the composition of XC2907-A portable reader, the internal structure of components and the working principle and interface description of each module.

## 4.1 Appearance description

The front view of XC2907-A portable reader is shown in Figure 4-1:

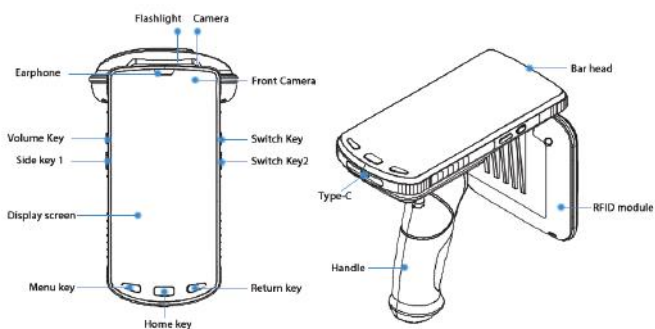

**Figure 4-1 Front view of XC2907-A portable reader**

### 1. Camera and barcode

Both modules are configuration modules. Barcode module provides 1D and 2D barcode adaptive function. Camera can be used for photography and other functions.

#### 2.RFID module

The external UHF-RFID module is adopted for XC2907-A portable reader;

#### 3.Battery

The battery is integrated with the rear cover and SIM card may be placed inside the tube holder on the side of the battery.

#### 4.Type-C interface

Power input port, which also supports OTG functions, can be used for data exchange between different devices or mobile devices. At the same time, it has the charging function.

#### 5.Side key

Custom function keys are generally used for UHF-RFID card reading control, or used as barcode scanning function keys.

## 4.2 Installation and removal of battery

[Battery installation]:

Place the battery, press down diagonally into the handle and tighten two screws

[Battery removal]:

Unscrew the nut, remove the handle obliquely upward and take out the battery obliquely upward.

## 4.3 Shutdown / Standby / Restart

[Startup/ Standby Wake-up]:

In the shutdown mode, long press the left power key of XC2907-A portable reader for 3S. The machine will turn on the boot screen, and then the system will enter the normal state.

In the standby mode, short press the left power key of XC2907-A portable reader. The screen will open and the system will enter the normal state.

[Shutdown/Restart]:

In the startup mode, long press the left power key of XC2907-A portable reader for 3S and select "startup/restart" according to the system prompt menu; If

"shutdown" is selected, the screen will be completely extinguished and the system will be turned off. If "restart" is selected, the screen will be briefly closed and then enter the boot screen.

[Reset operation]:

If the device crashes and any keystroke operation does not respond, you may need to reset and restart the device.

Operation methods: Pressing the device power key for more than 10s, the system will automatically restart.

## 5. Common functions and settings

### 5.1 Data synchronization between installing USB drive and PC

XC2907-A portable reader is connected to PC of Win7 and above system via the attached USB connecting line. The system will automatically install the driver to complete the connection process. If it is a WinXP system, you need to manually install the driver to connect it.

After successful connection, you can view the handset content via PC. If it cannot be viewed, you can view the operation by changing the connection mode. The specific steps are as follows:

- 1) Enter the main interface of handset;
- 2) Drag the screen and click "USB charging" and "file transmission".

As shown in Figure 5-1:

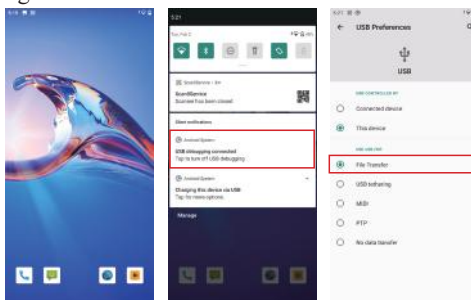

Figure 5-1 USB transmission

## 5.2 Backlight regulation

In the use of native equipment, users can set the backlight brightness of the screen as needed, i.e. "menu" → "settings" → "display" → "brightness". The brightness of LCD screen is regulated by moving the slide bar icon. See the details in Figure 5-2.

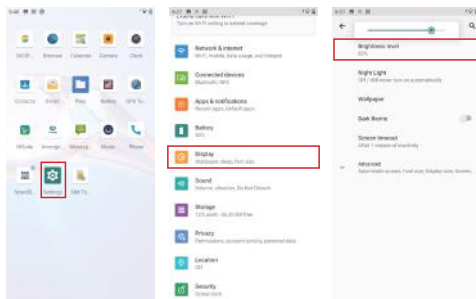

Figure 5-2 Brightness control

## 5.3 Volume and sound

During the equipment use process, the user may adjust the volume as needed and enter the volume control interface through "setting" and "prompt tone and notice". As shown in Figure 5-3:

The alarm clock and ringtone volume are set in the selected mode.

Multimedia volume is the last setting in the prompt tone and notification interface. Multimedia volume will affect the volume of RFID card reading sound and barcode reading sound.

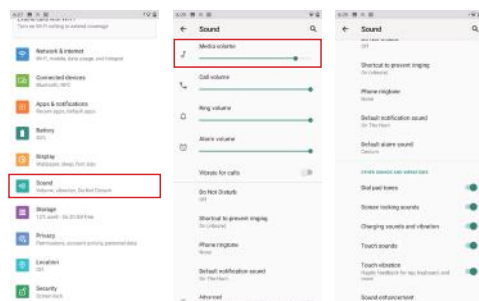

Figure 5-3 Volume and sound

## 5.4 Instructions for All-Netcom Network (data)

This reader supports all-Netcom network (data), thus extending the WWAN transmission function. The following is an introduction to common operations:

- Preparations: Properly insert a valid SIM card into SIM card slot in the handset battery compartment.
- Connection settings: Back to the main interface and scroll down the screen, it will see the automatic acquisition of the network connection. A long press the network icon, it will enter the mobile data interface, as shown in Figure 5-4:

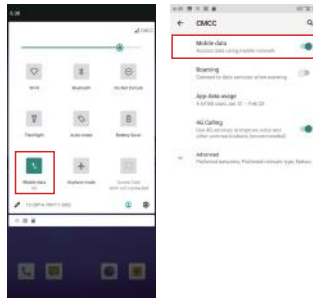

Figure 5-4 Network opening

## 5.5 Wi-Fi instructions

Wi-Fi function is configured to extend the wireless WLAN transmission function. The following is an introduction to common operations:

Opening settings: Slide the screen twice down the main interface, click the button and turn on Wi-Fi. As shown in Figure 5-5:

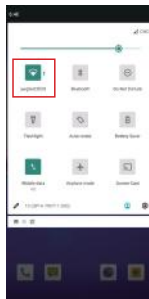

Figure 5-5 Wi-Fi Opening



Connection settings: After opening Wi-Fi, click WLAN below the icon, enter the connection interface, click Wi-Fi name to be connected, enter the password and finally complete the connection settings, as shown in Figure 5-6:

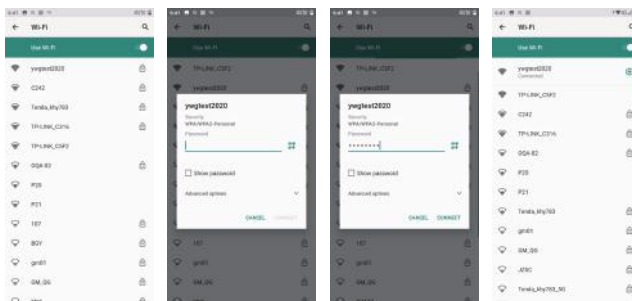

Figure 5-6 Wi-Fi connection setting

## 5.6 Instructions for Bluetooth

This equipment configures Bluetooth. The following is an introduction to common operations:

Opening settings: Slide the screen twice in the main interface, click the Bluetooth button and turn on Bluetooth. As shown in Figure 5-7:

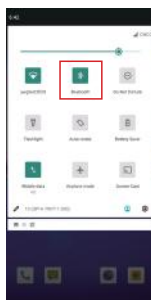

Figure 5-7 Bluetooth opening

Connection settings: When the Bluetooth module is turned on, click the "Settings" and "Bluetooth" interface, click the Bluetooth name to connect, and finally complete the connection settings, as shown in Figure 5-8:

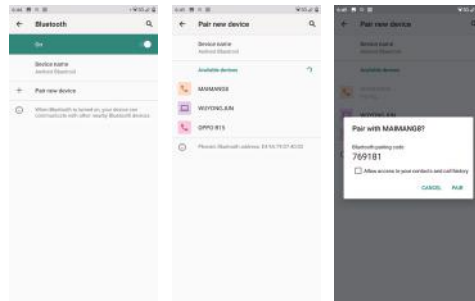

Figure 5-8 Bluetooth connection

## 5.7 Instructions for GPS

GPS opening method of this equipment is: Click the screen on both sides of the main interface, click "position information" button to successfully open GPS function. The interface is shown in Figure 5-9.

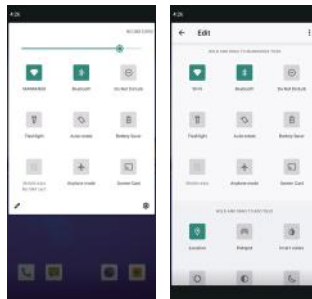

Figure 5-9 GPS Opening

## 5.8 Instructions for barcode module

### 5.8.1 Technical specification and support format for barcode engine

QR code:

Scanning Angle:  $\pm 40^\circ$

Scanning mode: trigger mode, interrupt mode

Readable code system:

1D code system: Code39, Code93, Code128, Codebar, EAN-13, EAN-8, UPC-A, UPC-E, ITF14, UCC/EAN-128, ITF25, Matrix25, EAN-128, ISBN, etc.

2D code system: PDF417, MicroPDF417, Composite, RSS, TLC-39, Datamatrix, QRcode, MicroQRcode, Aztec, MaxiCode, PostalCodes, USPostNet, USPlanet, UKPostal, AustralianPostal, JapanPostal, DutchPostal, etc.

### 5.8.2 Barcode reading of demo software

Enter the barcode Demo interface and click "scan" or side button to read the bar code, as shown in Figure 5-10:

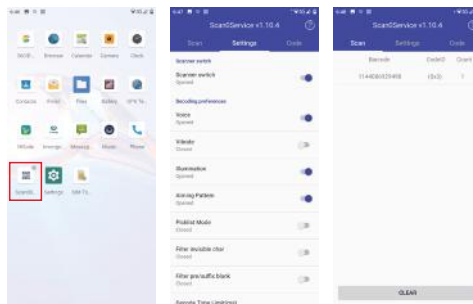

Figure 5-10 Barcode Demo



The secondary development method of barcode module refers to the *RFID Reader Universal API Technical Reference Manual*.



In order to ensure the correct reading rate and reading response time, please ensure the barcode window of XC2907-A portable reader is 20--30cm from the target barcode. When the barcode is printed on a smooth reflective object, keep the barcode window and the target barcode at an angle of 15 to 30° before reading; Otherwise, it may have a certain impact on the speed of reading.

Remarks:

Before using this function module, make sure that XC2907-A portable reader has installed this optional function module; If it is not installed, you may contact the salesman of INVENGO for further support.

## 5.9 Instructions for camera

XC2907-A portable reader configures 13 million pixel camera to take photos

Brightness, resolution and screen capture can be adjusted. At the same time, the camera supports automatic focusing and flash function.

Click the camera to take photos.

## 6. Introduction for RFID module

### 6.1 Description of RFID module

#### 6.1.1 Module instruction

This RFID module can read the tags manufactured by different manufacturers that conform to EPC Global UHF Class 1 Gen 2/ISO18000-6C and ISO18000-6B protocols. It is suitable for mixed use of different protocols.

#### 6.1.2 Technical parameters of RFID module

- Frequency: 902MHz-928MHz
- RF Output Power: 0dBm~30dBm, stepping 1dB;
- Modulation mode: ASK modulation
- Working mode: Fixed frequency mode, frequency hopping mode
- Read tag distance: 0m~10m (relevant to the power and tag environment)
- Write tag distance: 0m~5m (relevant to the power and tag environment)

UHF Antenna:

- Direction of polarization: RHCP (Circular polarization)
- RF Antenna gain: 4dBi
- Standing-wave ratio: 1.5:1
- 6C tag data capacity supported: EPC maximum capacity supports 62 bytes; TID maximum capacity supports 14 bytes. The maximum capacity of user data field supports 8K bytes.

- 6B tag data capacity supported: Tag ID maximum capacity supports 8 bytes. The maximum capacity of user data field supports 216 bytes.



*The tag capacity can increase with software upgrades. This list is used for reference only.*

Introduction to TID:

TID (Tag Identifier) is a sign of identity distinction between tags. From the point of view of security and anti-counterfeiting, TID of the tag is unique; TID of a tag that is no longer activated even in a killed state should not appear in another tag. Even if the data in other regions of the tag are copied, it can be distinguished by a unique TID.

Composition of tag TID area: class identification code (8bit) + manufacturer code (12 bit) + tag model (12 bit) + tag SN (Label manufacturers have different capacities)

## 6.2 Instructions for API interface program

API application interface is the middle layer between XC2907-A portable reader and background application software, which provides a software interface for user secondary development.



*About API application interface program call and application software development, refer to the RFID Reader Universal API Technical Reference Manual.*

## 6.3 Instructions for demo software

The demo software mainly performs system control, parameter setting, parameter query, and radio frequency tag read/write and display demonstration functions for XC2907-A portable reader.

### 6.3.1 Demo software application environment

Android10.0

### 6.3.2 Software installation and start-up

I. Installation mode: Drag InvengoDemo.apk file to the handset or handset memory, click file management, find the file location and click to install it.

II. Startup mode: Click on the "InvengoDemo" icon on the system main interface to start the demo program. As shown in Figure 6-1:

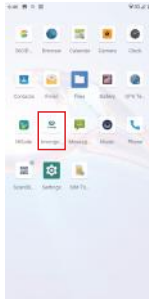

Figure 6-1 Main interface of XC2907-A portable reader

### 6.3.3 Software running

Run the application and demonstrate the software interface as shown in Figure 6-2:

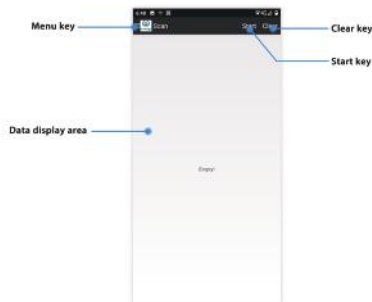

Figure 6-2 Main page of demo software

- 1) Menu key: Click on the menu key to pop up the system menu
- 2) Start key: Click the start key to start reading the tag and click again to stop reading the tag. (You can read the tag by side key. Press once to start reading the tag and press once to stop reading the tag)
- 3) Clear key: Clear the data content displayed in the data display area.
- 4) Data display area: The read tag content will be displayed in the data display area.

Notes: After Demo is turned on, only when the main page of the demo software is pressed, can the card reading operation be carried out or the card reading operation be stopped. The other interface side keys are invalid.

## 6.4 Main operating instructions for demo software

### 6.4.1 Scan Setting

The entry method of the scan settings interface is "Menu" and "Scan Settings", as shown in Figure 6-3:

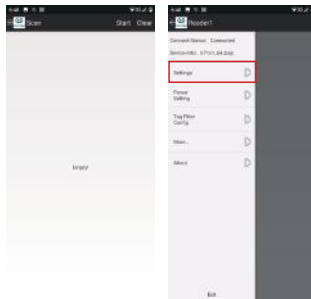

Figure 6-3 Scan settings

The main function of scanning setting is to set read tag type, read area, read length, see Figure 6-4 for details:



Figure 6-4 Scan settings

1) Save: When the settings are complete, click "Save" to save the setting data.

- 2) Prompt tone: Check to open the card reading sound of handset.
- 3) RSSI: Check to display RSSI value.
- 4) Operation type: Set the card reading type.

Option	Description
Single	After opening the reading card, read the tag only once.
Cycle	After opening the reading card, read all tags in cycles.

- 5) Tag type: Set the type of read tag.

Option	Description
6C	Only read 6C tag
6B	Only read 6B tag
6C&6B	Read 6C and 6B tags
GB	Only read GB tag (XC2907-A does not support the operation)

- 6) Read EPC: Only read EPC area of the tag.
- 7) Read TID: Only read TID area of the tag.
- 8) General reading: Read EPC, TID and user area.
- 9) TID Length: Set the TID length to be read.
- 10) User data initial address: Set the initial address to read the user area.
- 11) User data length: Set the reading length of data in the user area.



*Notes: TID length, user first data address, user data length can only be set when they are available.*

### 6.4.2 Power setting

The mode to enter the power setting is "menu" and "power setting." The detailed introduction can be shown in Figure 6-5:



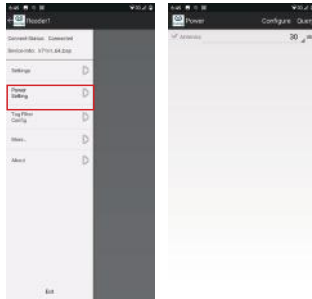

Figure 6-5 Power Setting

- 1) Configuration: Save the antenna power being set.
- 2) Inquiry: Inquire the antenna power that has been set.
- 3) Antenna: The power varies as per the hardware.

### 6.4.3 Tag filter configuration

The mode to enter the tag filter configuration is "Menu" and "Tag Filter Configuration." The detailed introduction can be shown in Figure 6-6:

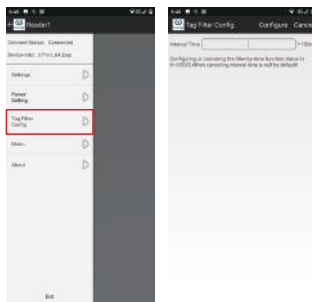

Figure 6-6 Tag Filter Configuration

- 1) Configuration: Configure as per the interval time that has been entered.
- 2) Cancellation: Cancel the Tag Filter Setting.
- 3) Interval time: Set the repeated tag filtering time, the time is 0s~6553.5s.

### 6.4.4 Search the tag

The mode to enter the search tag is "Menu" "More," the detailed introduction can be shown in Figure 6-7:

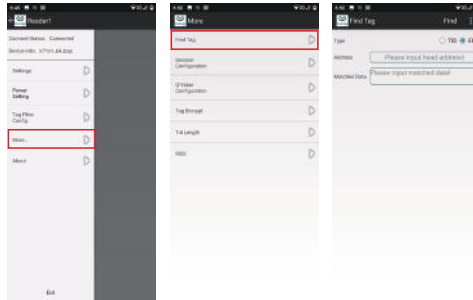

Figure 6-7 Search Tag

- 1) Start: Start to search the tag
- 2) Type: The search location is TID or EPC.
- 3) First address: Search the first address of the tag.
- 4) Match data: The content to search tag.

### 6.4.5 Session configuration

The mode to enter the search tag is "Menu" "More" "Session Configuration," the detailed introduction can be shown in Figure 6-8: (The recommended configuration for reading multiple tags is session S1, A symbol)

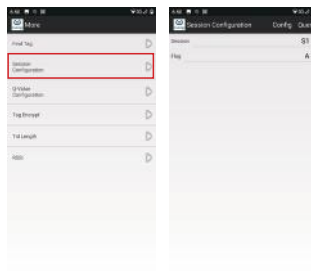
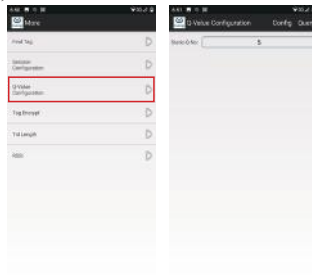

Figure 6-8 Session Configuration

- 1) Configuration: Save the parameter being set.
- 2) Inquiry: Query the parameters that have been set.
- 3) Session: Set the session types, and the session types fall into S0, S1, S2, S3.
- 4) Logo: Set the logo, the logo has A symbol, B symbol, A&B symbol.

### 6.4.6 Q value configuration

The mode to enter the search tag is "Menu" "More" "Q Value Configuration," the detailed introduction can be shown in Figure 6-9: (Q value recommended configuration 3~5)



**Figure 6-9 Q Value Configuration**

- 1) Configuration: Save the parameter being set.
- 2) Inquiry: Query the parameters that have been set.
- 3) Static Q value: The Q value is associated with the number of pre-read tags, and the starting Q value can be set here.

## 7. Tag operation

The mode to enter the tag operation is: Click the tag with operation to enter the tag operation interface. The detailed operation can be shown in Figure 7-1:

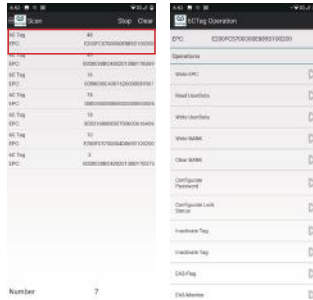

Figure 7-1 Tag Operation

1) After reading the tag, click the tag to be operated, and enter the tag operation interface.

## 7.1 Writing EPC

The entry mode of writing EPC is "tag operation" and "writing EPC", the detailed introduction can be shown in Figure 7-2:

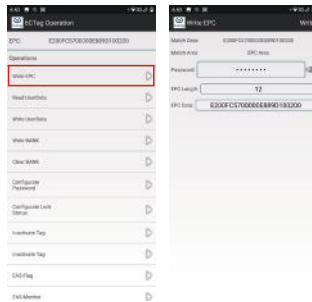

Figure 7-2 Writing EPC

- 1) Write in: Write EPC as per the input content.
- 2) Access password: Enter the tag access password.
- 3) EPC Length: Enter the length to be written.
- 4) EPC data: Enter the content to be written.

## 7.2 Read user field data

The access method of reading user data field is "tag operation" and "read user data field". The detailed introduction can be shown in Figure 7-3:

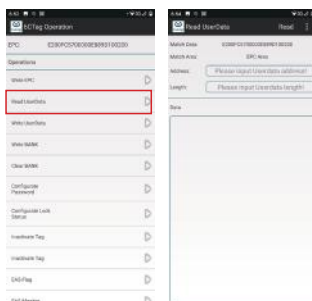

Figure 7-3 Read User Data

- 1) Read: Read the data pursuant to the filling content.
- 2) First address: Read the first address of the user field.
- 3) Length: The length to be read from the first address.
- 4) Data: The data content to be read.

## 7.3 Write user field data

The access method of writing user data field is "tag operation" and "write user data field". The detailed introduction can be shown in Figure 7-4:

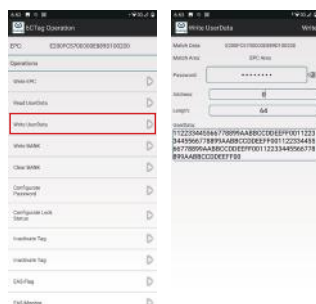

Figure 7-4 Write User Data

- 1) Write in: Write user field as per the input content.
- 2) Access password: Enter the tag access password.
- 3) First address: Enter the first address for writing.
- 4) Length: Enter the writing length.
- 5) User data: Enter the content to be written.

## 7.4 Writing BANK

The entry mode of writing BANK is "tag operation" and "writing BANK," the detailed introduction can be shown in Figure 7-5:

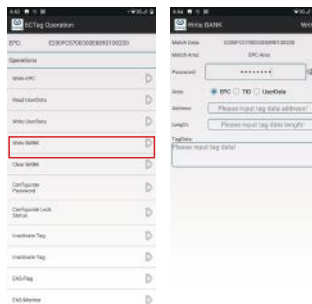

Figure 7-5 Writing BANK

- 1) Write in: Write pursuant to the input content.
- 2) Access password: Enter the tag access password.
- 3) Operating area: Select the writing area, EPC, TID or user field.
- 4) First address: Enter the first address for writing.
- 5) Length: Enter the writing length.
- 6) Tag data: Enter the writing data.

## 7.5 Wiping BANK

The access mode of wiping BANK is "tag operation" and "wiping BANK." The detailed introduction can be shown in Figure 7-6:

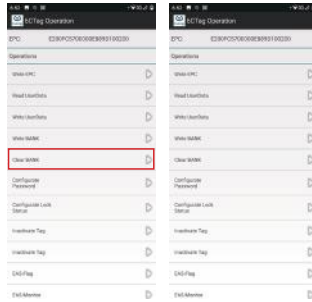

Figure 7-6 Wiping BANK

- 1) Erasing: Wipe as per the input content.
- 2) Access password: Enter the tag access password.
- 3) Operating area: Select the wiping area, EPC, TID or user field.
- 4) First address: Enter the first address for wiping.
- 5) Length: Enter the wiping length.

## 7.6 Configuration password

The mode to enter the configuration password is "tag operation" and "configuration password". The detailed introduction can be shown in Figure 7-7:

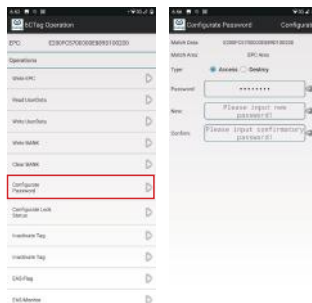

Figure 7-7 Configuration Password

- 1) Configuration: Configure the password as per the input content.

- 2) Configuration type: Choose to configure access password or destroy password.
- 3) Access password: Input the original password.
- 4) New password: Enter the password to be configured.
- 5) Confirm your password: Repeat the new password.

## 7.7 Configure lock status

The mode to enter the configuration lock state is "tag operation" and "configuration lock state." The detailed introduction can be shown in Figure 7-8:

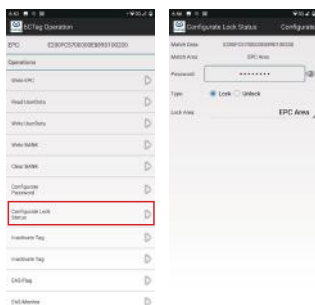

**Figure 7-8 Configuration Lock State**

- 1) Configuration: Configure the lock state pursuant to the input content.
- 2) Access password: Enter the tag access password.
- 3) Operation type: It can select the locking or unlocking state.
- 4) Locking area: Select the operating area.

Option	Description
All areas	Conduct operations in all areas
Area TID	Conduct operations in TID
Area EPC	Conduct operations in area EPC
User data field	Conduct operations in user data field
Access password field	Conduct operations in access password filed
Destroy the password field	Conduct operations in destroying password filed



## 7.8 Inactivation tag

The entry mode of inactivation tag is "tag operation" and "inactivation tag," the detailed introduction can be shown in Figure 7-9:

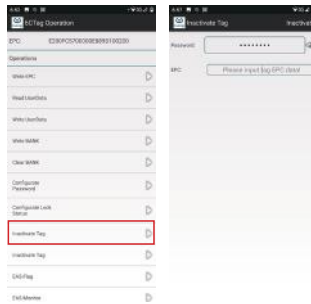

Figure 7-9 Inactivation Tag

- 1) Inactivation: In accordance with the input information, the tag is inactivated.
- 2) Inactivated password: Enter inactivated password.
- 3) EPC: Enter the EPC to inactivate the tag.

## 7.9 EAS logo configuration

The access mode of EAS logo configuration is "tag operation" and "EAS logo configuration," the detailed introduction can be shown in Figure 7-10:

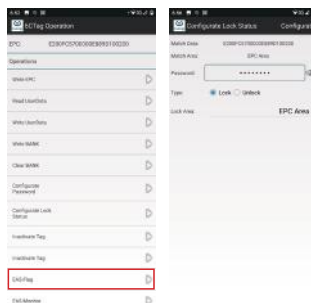

Figure 7-10 EAS Logo Configuration

- 1) Configuration: Configure the EAS logo configuration as per the input content.
- 2) Access password: Enter the tag access password.
- 3) Operation type: Carry out configuration or cancellation.

## 7.10 EAS Monitoring configuration

The access mode of EAS monitoring configuration is "tag operation" and "EAS monitoring configuration," the detailed introduction can be shown in Figure 7-11:

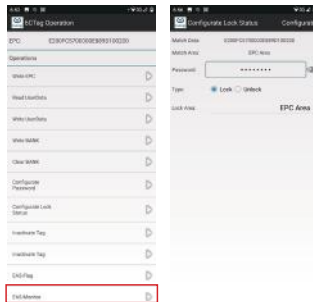

Figure 7-11 EAS Monitoring Configuration

- 1) Start: Start the EAS monitoring configuration.
- 2) Stop: Stop EAS monitoring configuration.

## 7.11 EPC filter

The entry mode of writing EPC filter is "tag operation" and "EPC filter," the detailed introduction can be shown in Figure 7-12:

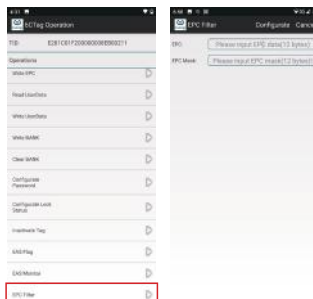

Figure 7-12 EPC Filter

- 1) Configuration: Configure pursuant to the input content.
- 2) Cancellation: Cancel the EPC filter setting.
- 3) EPC: Enter the matching data (12 bytes).
- 4) Matching mask: Enter the matching mask (12 bytes).

## 8. Precautions

### 8.1 Description of use of power saving

To enhance the endurance of the whole machine and ensure that the users can better control the long-term operation of the communication module, the equipment adopts a flexible power control scheme. Please follow the suggestions below as per your actual application.

#### 1. Power consumption control:

In this machine, it can set the time to automatically enter the power saving standby state. Enter the standby mode by setting the automatic sleep time (provided that there is no operation for a certain period of time, it will automatically enter the standby mode). The setting method is as follows: "Settings" "Display" "Sleep." The standby mode can be entered by pressing the red power button.

#### 2. Module control:

Under the standby mode, the power of all modules will be turned off, and the system is close to the shutdown state.



*Please note that in case that you want to extend the normal operation time of the device as much as possible. In the event that the conditions permit, it is recommended that you can charge it at any time when it is idle for a long time.*

### 8.2 Exception declaration

In case that the device suddenly fails to be operated, the 3 status indicators will display the error status indication. In the event that the device fails to be operated normally after installing the battery, the device must be restarted. Pressing the red power key for more than 10s, the system will automatically restart.

### 8.3 The correct mode to replace the battery

When the device's battery needs to be operated, the device should be put into the standby state first, and then replace the battery.

The battery shall be replaced within 30 s, and the time and date will not be lost provided that the device is restarted.



*In case that it times out, the time and date set by the device will be lost.*

## 9. Daily maintenance and troubleshooting

### 9.1 Routine maintenance

Store the whole machine in a dry and cool place with a temperature range of 10°C~40 °C. Don't contact with corrosive substances, and keep away from fire and heat sources (refer to 10.2 storage requirements for details).



*Because the lithium battery possesses self-discharge characteristics, provided that the device failed to be used for a long time (not less than 1 month), it is recommended that you take the battery out of the handheld device and store it separately (40% of the battery is most suitable for long-term storage. In the event that the conditions permit, the battery should be charged and discharged every three months).*



*Precautions for battery*

1. Don't connect its input terminal directly to the output terminal;
2. Don't put the battery into water or get it wet;
3. Don't use or store batteries near heat sources (such as fire or heaters);
4. Please use the original charger;
5. Don't connect the positive and negative poles reversely;
6. Don't directly connect the battery to the wall socket or vehicle-mounted cigarette lighter socket;
7. Don't throw the battery into the fire or heat the battery;
8. It's forbidden to cause the short circuited positive and negative electrodes of

the battery with wires or other metals, avoid transporting or storing the battery with necklaces, hairpins or other metal objects;

9. Don't disassemble the battery or cause the battery to short circuit;

10. Don't hit against the battery or hit against the battery with sharp objects.

## 9.2 Analysis and troubleshooting of common problems

In this section, it introduces how to handle common problems or abnormal phenomena in the device provided that the users use the XC2907-A portable reader.

- **What is "restart" and how to implement "restart" operations.**

"Restart" is the most common system startup mode in the device, namely, the system is forced to be powered off and then restart.

By pressing the "RST" button in the lower left corner of the keyboard or long pressing the "red power button," then the system can be restarted.

- **No backlight**

Please check that whether you have clicked the "Backlight Adjustment" button to the lowest level or not;

Please check whether the "red power button" is pressed.

- **No sound**

Please check if the system volume is adjusted to the minimum.

- **It displayed a black screen in the system and nothing occurs when you click on the screen**

Whether it is in the standby state, please short press the "red power button," so that the system can be started up;

Please check whether the battery is loose.

- **Provided that the power adapter or battery is plugged in, the handset does not start normally (black screen)**

Blank screen:

1. Check whether the power adapter is not inserted tightly or whether the battery is not installed or contacted appropriately. Perhaps the battery is low and it will take a few minutes before it is displayed.

2. Check whether the PC machine connects to the handset through the USB cable. Provided that there is a connection, please hold on for a few minutes; Maybe the battery level is too low, and the battery needs to be charged for a while before displaying the electricity.

- **Can't read the tag**

Please confirm that whether the electronic tag is in the effective range of the reader;

Please confirm whether the space RF signal interference problem exists.

- **Avoid writing tag**

Please confirm that whether the electronic tag is in the effective range of the reader;

Please confirm whether the data field of electronic tag is locked;

Please confirm whether the parameters for instruction writing are configured correctly;

Please confirm whether the space RF signal interference problem exists.

- **Why is the distance of written tag closer than the distance of read tag?**

The RFID technology features decide the energy needed to write tag is far larger than that needed to read tag, so the distance of written tag and the success rate are lower than that of read tag.

- **Why do different tags have large reading difference?**

Due to the RFID technology features, different tag chips and their package medium cause tags have completely different sensitivity to reader. So the operation distance and success rate are completely different.

For the problems that users can't solve voluntarily, please contact Invengo Company to negotiate repair matters. Refer to the after-sales service information for details.

## 9.3 RF communication optimization

Under normal circumstances, the system performance of equipment adopting radio technology for communication is very sensitive to signal interference and attenuation. Some prompts are offered to solve the RF communication optimization problems between XC2907-A portable reader and electronic tag.

### 9.3.1 Signal interference problem

Signal interference refers to the RF signal bringing interference upon the information exchange between portable reader and electronic tag. Signal interference can severely reduce the ability of portable reader in reading electronic tag data information.

Interference signal can be from

- RF system, such as: RF local-area network and adjacent interactive identification system;
- RF signal radiated by safety door, garage door or other devices;
- Other RF radiation source.

If RF interference or noise exists, the performance of portable reader system (data information exchange with electronic tag) will reduce significantly. Portable reader can only "receive" one signal at any time. It can't distinguish the unexpected "noise" and expected "useful RF signal".

### 9.3.2 Information attenuation / reflection

Information attenuation refers to the natural attenuation of signal strength with the increase of distance, and can refer to the attenuation of signal caused by barrier in transmission path.

RF signal transmission obstacles may be caused by:

- Confined space containing concrete wall, floor and ceiling;
- Metal surface by centering on antenna or tag;
- Water or other liquids by centering on antenna or tag;

Almost every kind of object (furniture or partition) in RF signal transmission path will cause different degrees of signal attenuation. The RF signal attenuation caused by barrier can be minimized by carefully adjusting the installation location of antenna.

The reflection formed on the surface of metal or metallization behind the electronic tag may also influence the signal attenuation. In some cases, such influence could slightly increase the read range, and would also form some dead angles in the reading area. When electronic tag is located at position of those dead angles, the communication between it and portable reader will become very bad.

In general condition, it is impossible to accurately predict the performance of portable reader system performance in any given environment due to the complexity of electrical magnetic radiation, including the frequency stability of signal source, directional diagram and sidelobe problem of antenna, ambient environment, etc.). But, some suggestions given below can guide the optimization of system performance in specific environment and application conditions.

- In consideration of RF characteristics, including the building materials, office hours, configuration condition of window and pipeline, RF field mode and read distance may be influenced by the adjacent metal objects, such as household appliance, equipment, metal framework, etc.
- Ensure that the objects which are to be recognized and contain electronic tag, remain in the effective reading area of portable reader for no less than 100ms.
- The length of antenna with the best electronic tag is related to the sealed or embedded nonconductive materials. Basic concept: For the electronic tag embedded in non-conductors (dielectric constant is larger than that in air, causing that the effective wavelength in medium is shorter than the effective wavelength in air), if its effective electrical length is adjusted to the optimum length in air (farthest from the red distance of portable reader), the electrical length of tag antenna shall be adjusted toward the shrinkage direction when electronic tag is put in non-conductor or on substrate in order to reach the best effect equal to that in air. On the contrary, if the effective electrical length of electronic tag antenna is adjusted to the best electrical length in the non-conductor medium, the best electrical length in the air shall be adjusted toward the direction electrical length increase.
- The exposed and unpackaged electronic tag isn't allowed to contact chemical medicines. Some chemicals, such as ethyl alcohol, would not influence electronic tag at normal temperature, but will corrode electronic tag at high temperature.



## 10. Transport and storage

### 10.1 Transport requirements

XC2907-A portable reader conforms to the requirements as specified in the relevant standards of highway, railway transport, aviation, water transport, etc.

### 10.2 Storage requirements

The warehouse for long-term storage of XC2907-A portable reader shall comply with the following conditions:

- Ambient temperature:  $-10^{\circ}\text{C}\sim 40^{\circ}\text{C}$ ;
- Relative humidity: Not more than 80%;
- No sharp temperature change, and no acid gas and other harmful gas in ambient air;
- Since lithium battery conduct self-discharge, you shall take out battery from handheld devices for separate storage in case of nonuse of the equipment for a long time (no less than 1 month);

## 11. Packing and unpacking inspection

### 11.1 Packing descriptions

XC2907-A portable reader adopts box packaging and can use the large-transport turnover box.

### 11.2 Unpacking

Please unpack before properly saving packing box and packing materials to facilitate the future storage and transport.



*Please seriously check whether product and accessory are complete in accordance with the container loading list of product. Please promptly contact our company in case of any unconformity or damage.*

## 12. After-sales service method

### 12.1 After-sales service

Users shall contact our company's Customer Service Center in case of meeting the indecisive problems when using the portable reader.

Users shall record the following information before contacting our company's Customer Service Center:

- Portable reader's model
- Portable reader's serial number (at the bottom of portable reader)
- Any alteration made on portable reader or tag;
- Application software condition of portable reader

### 12.2 Other items

If our company's Customer Service Center confirms users need to return portable reader for repair, Customer Service Representative will give you a Return Merchandise Authorization (RMA). Please write such number outside the return system packing box and on a note in the packing box. In this way, the items returned by users will be rapidly processed.

Please return portable reader for repair as per the following steps:

- Carefully pack the portable reader and its accessories in the original anti-static foam packing box. If the original packing box is lost, please select a protective packing box;
- Cover the articles in box with filling materials;
- Add a note with RMA Number written to packing box;
- Write the RMA Number and the word "fragile" outside the packing box.



## Regional Sales Offices

### APAC Sales:

#### Invengo Technology Pte. Ltd.

10 Kallang Avenue  
#05-15 Tower 2, Aperia  
Singapore 339510  
Tel: +65 6702 3909  
Email: sales@invengo.com  
Website: www.invengo.cn

### Korean Sales:

30F ASEM Tower  
517 Yeongdong-daero  
Gangnam-gu,  
Seoul 135-798, Korea  
Tel: +82 2 6001 3525  
Email: sales@invengo.com

### AMERICAS Sales:

1011 S HAMILTON RD  
Ste 300 CHAPEL HILL  
NC 27517-4409 USA  
Tel: +1 919 890 0202  
Email: sales.americas@invengo.com

### EMEA Sales:

Ceresstraat 1, 1st floor  
4811 CA Breda  
The Netherlands  
Tel: +31 85 1300 401  
Email: sales.emea@invengo.com

## Dedicated Market Offices

### Global Textile Solutions: Invengo Technologies.

180 Voie Ariane – Athélia 1  
13600 La Ciotat  
France  
Tel: +33 413 96 1111  
Email: sales.textile@invengo.com

### Global Library Solutions: FE Technologies.

129 Fyans Street  
South Geelong 3220  
Victoria Australia  
Tel: +1300 731 991  
Email: enquiries@fetechgroup.com

### Global Handhelds Solutions: ATID Co. LTD.

#1402, 83,  
Gasam digital 1-ro,  
Geumcheon-gu, Seoul  
Republic of Korea, 08589  
Tel: +82 544 1436  
Email: inquiry@atid1.com